

**SS-110F01**

Rating: 0.5A 50V DC  
Function: 1P10T

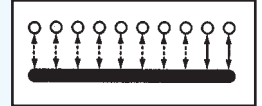

**S** SHORTING

Optional Knob type

GE					

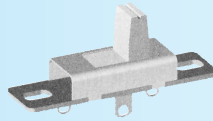
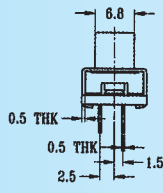
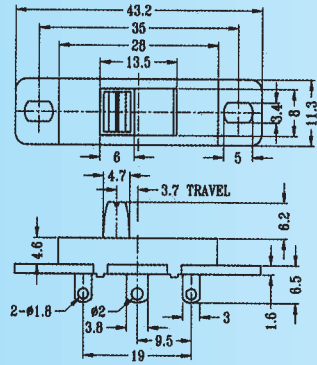

**SS-143D04**

Rating: 1A 250V AC  
2A 125V AC  
Function: 1P43T

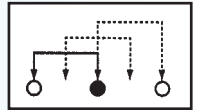

**N** NON-SHORTING

Optional Knob type

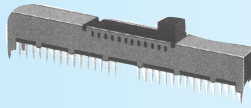
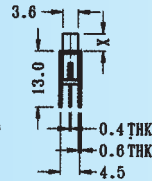
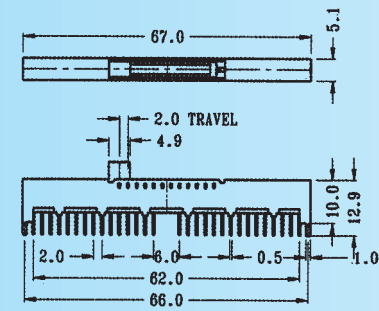

**SS-212D11**

Rating: 0.3A 50V DC  
Function: 2P12T

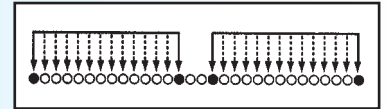

**S** SHORTING

Optional Knob type

TA					

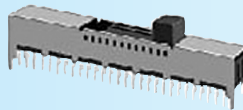
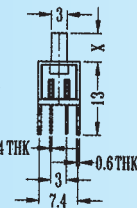
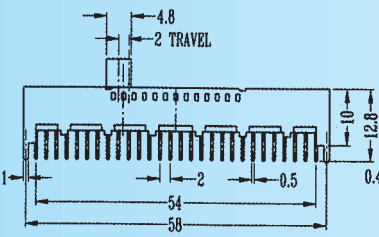

**SS-412D01**

Rating: 0.3A 50V DC  
Function: 4P12T

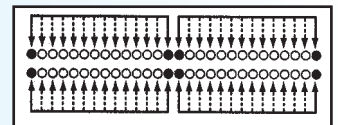

**S** SHORTING

Optional Knob type

TA					

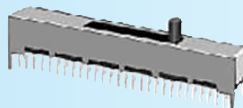
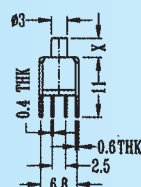
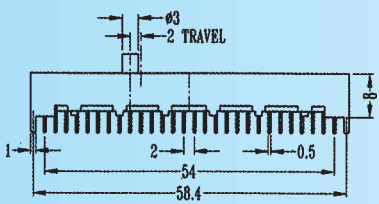
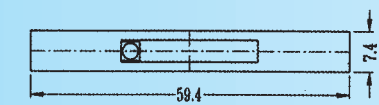

**SS-412D02**

Rating: 0.3A 50V DC  
Function: 4P12T

**S** SHORTING

Optional Knob type

NT					