

## ST-215 SERIES (3.5 mm)

Optional Accessory: AZ-004

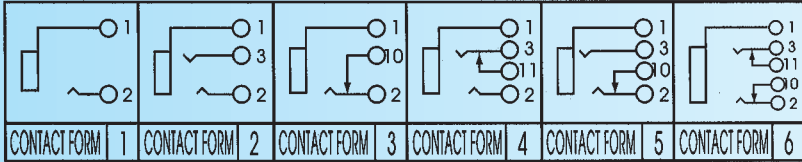

### ORDER INSTRUCTION

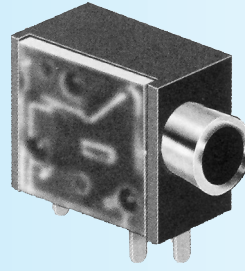
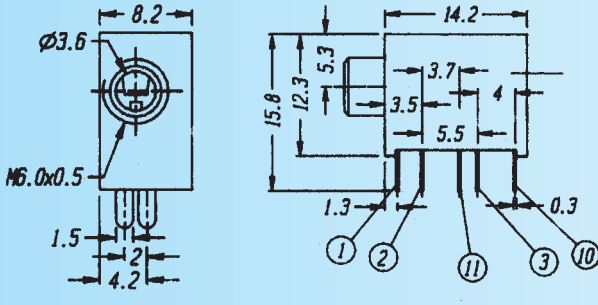
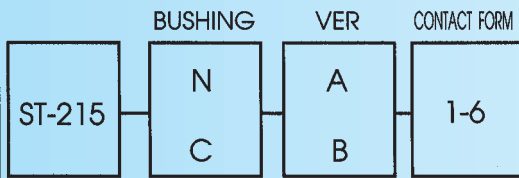

### VERSION: COLOR OF COVER

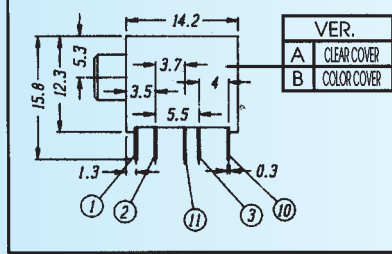

### BUSHING TYPE

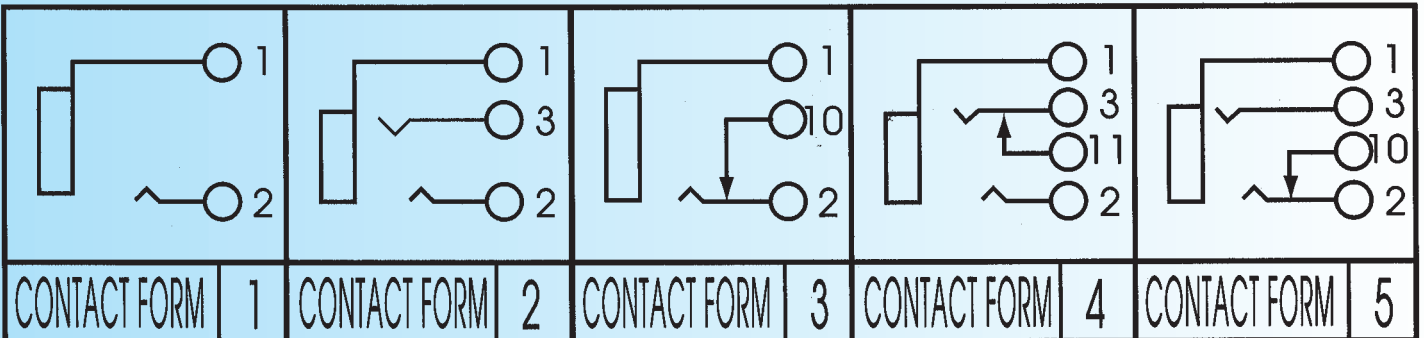
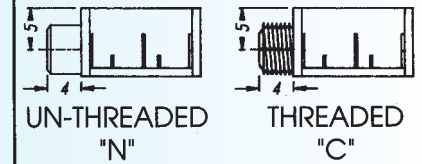

### SCHEMATIC

